

*in- depth heating
technology*



THERMALL

HEATING RADIATOR BOILERS



→ Heating Radiator Stoves

→ Heating Stoves

→ Workplace Stoves

→ Using Water Heaters

www.thermall.com.tr

ISIKSAN
ISIKSAN HEATING SYSTEMS

ABOUT US

www.thermall.com.tr

In 1990, heating with 'heating radiator systems technology', had to develop a lot of products that to be easy life for peoples. In this period, our team closely followed the developments in the heat sector, has analyzed the need in the field well and in 1998, "IŞIKSAN HEATING SYSTEMS" company was founded. Our company, primarily Turkey's first 'Can be load in an Apartmanet Solid Fuel Boilers with Alarm System' model producted with **FIRELINE** mark. product diversity. In 2015, the company launched the **THERMALL** branded products in order to renew its products and brands.

IŞIKSAN HEATING SYSTEMS, solid fuel boiler, work place stove, boiler, expansion tank and heat exchanger production as well as heating, natural gas and installation equipment installation, proving itself in the heating of detached villas, flats, duplex villa type houses and workplaces up to 1000 m², wholesale and retail sales also provide complete services.

IŞIKSAN HEATING SYSTEMS, which has become more and more talked about with its expert staff, superior service quality, customer oriented approach and life-facilitating heating solutions, has become a company that will become a brand of the future.



OUR VISION

To solve the health problems caused by the warming problem, to develop the heating solutions that are the main theme and to make life easier by making life easier.

OUR MISSION

Advanced technology, strong equity, high human values, representing international norms and becoming a brand in the sector.

CERTIFICATE



KS SERIES

T-15 KS

HEATING RADIATOR STOVES WITH BUCKET AND FAN

Manuel Control Panel
Fan System
Circulation System
Firing are with Bucket
Firing all Kinds of Fuel
Conventional Ways
Decorative Cabinet
Aluminium Profiles



Coal



Cone



Wood



Turd



Silent Working Fan



Manuel Air Circulation



Locking System



High Stave Bucket



Convedion Ways



Manuel Control Panel



Stative Colorfull Cabinet



TECHNICAL SPECIFICATIONS

Capacity:	15 000 kcal/h
Radiator Lines:	1"
Ventile Lines:	3/4"
Flue Diamenter:	130 mm
Water Volume:	20 L
Weight:	55 Kg
Dimensions:	
Width	500 mm
Depth	500 mm
Height	800 mm

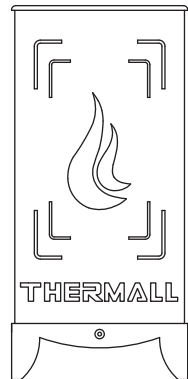
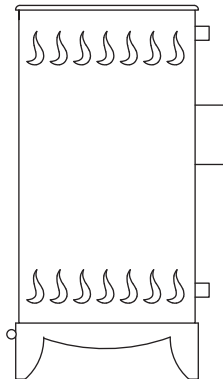

KS SERIES T-20 KS

HEATING RADIATOR STOVES WITH BAKERY, BUCKET AND FAN

Manuel Control Panel
Fan System
Circulation System
Firing are with Bucket
Firing all Kinds of Fuel
Conventional Ways
Decorative Cabinet
Aluminium Profiles
Bakery For Cook



Coal



Cone



Wood



Turd



Silent Fan



Manuel Circulation System



Lock System



Oven Handle

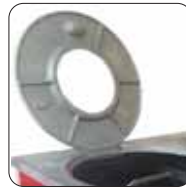

Casting Bucket Cover



Large Bakery



Manuel Control Panel



TECHNICAL SPECIFICATIONS

Capacity:		20 000 kcal/h
Radiator Lines:		1"
Ventile Lines:		¾"
Flue Diamenter:		130 mm
Water Volume:		25 L
Weight:		80 Kg
Dimensions:	Width	890 mm
	Depth	500 mm
	Height	750 mm

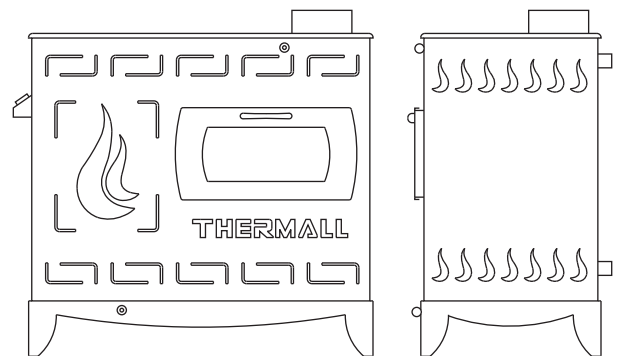

SK SERIES T-25 DSK

VERTICAL FIREPLACE OVEN HEATING BOILER

- Manuel Control Panel
- Large Loading Cover
- Elimination and Tilting Lever
- Clock and Fan System
- Flames
- Replaceable Grid
- Maneuver Sieving-Tilting
- Isolation Silent Work
- All Solid Kinds Firing Oppotional
- Cleaning Front Opportunity
- Conventional Ways
- Decorative Cabinet
- Cooking Oven



Coal



Cone



Wood



Turd



Elimination and Tilting Lever



Manuel Control Panel



Loading and Fireplace Cover



Large Volume Cooking Oven



Convection Ways



Silent Working Chain Valve



Large Volume Fuel Tank



TECHNICAL SPECIFICATIONS		
Capacity:	25 000 kcal/h	
Radiator Lines:	1"	
Ventile Lines:	3/4"	
Flue Diamenter:	130 mm	
Water Volume:	45 Lt	
Weight:	130 Kg	
Dimensions:	Width	600 mm
	Depth	680 mm
	Height	1300 mm

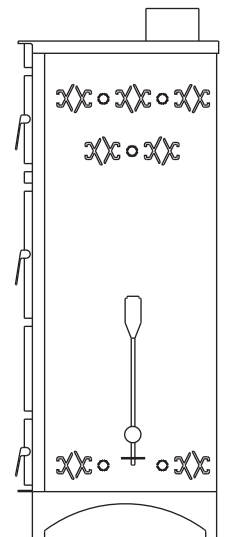
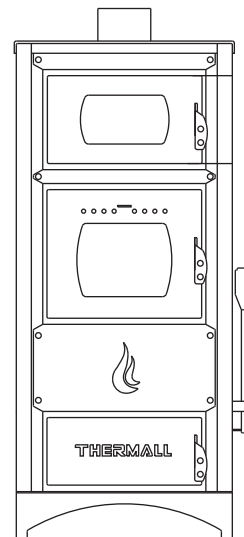

SK SERIES T-25 YSK

HORIZONTAL FIREPLACE OVEN HEATING BOILER

- Manual Control Panel
- Large Loading Cover
- Elimination and Tilting Lever
- Clock and Fan System
- Flames
- Replaceable Grid
- Maneuver Sieving-Tilting
- Isolation Silent Work
- All Solid Kinds Firing Opportional
- Cleaning Front Opportunity
- Conventional Ways
- Decorative Cabinet
- Cooking Oven



Coal



Cone



Wood



Turd



Elimination and Tilting Lever



Manual Control Panel



Loading and Fireplace Cover



Large Volume Cooking Oven



Convection Ways



Silent Working Chain Valve



Second Furnace



TECHNICAL SPECIFICATIONS

Capacity:		25 000 kcal/h
Radiator Lines:		1"
Ventile Lines:		3/4"
Flue Diameter:		130 mm
Water Volume:		45 Lt
Weight:		195 Kg
Dimensions:	Width	1070 mm
	Depth	600 mm
	Height	950 mm

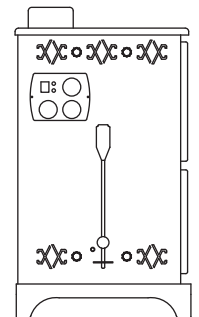
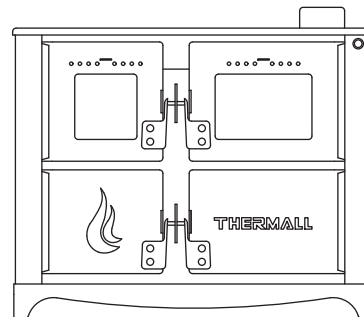

MYK SERIES

T-22/100 MYK

MANUEL LOADING HEATING RADIATOR SOLID FUEL BOILERS

- Manuel / Digital Control Panel
- Curtain Cover System
- Large Loading Cover
- Alarm System
- Elimination and Tilting Lever
- Clock and Fan System
- Flames
- Replaceable Grid
- İzolation Silent Work
- Large Volume ash Pail
- All Solid Kinds Firing Opportional
- Cleaning Front Opportunity



Coal



Cone



Wood



Turd



Optional Manuel Control Panel



Optional Digital Control Panel



Optional Clack



Optional Fan



Elimination and Tilting Lever



Curtain Cover



Dish- Shaped Grid

TECHNICAL SPECIFICATIONS

Product Code	Capacity (kcal/h)	Dimensions			Radiator Lines	Ventile Lines	Output Fullingline	Flue Diamenter (mm)	Water Volume (Lt)	Weight (Kg)
		Width (mm)	Depth (mm)	Height (mm)						
T-22 MYK	22 000	500	470	1160	1"	3/4"	1/2"	130	40	113
T-28 MYK	28 000	500	580	1265	1"	3/4"	1/2"	130	50	144
T-35 MYK	35 000	545	580	1365	1"	3/4"	1/2"	130	65	157
T-45 MYK	45 000	545	650	1465	1 1/4"	3/4"	1/2"	150	80	193
T-60 MYK	60 000	600	790	1465	1 1/2"	3/4"	1/2"	150	100	231
T-80 MYK	80 000	600	790	1565	1 1/2"	3/4"	1/2"	180	125	247
T-100 MYK	100 000	600	850	1665	2"	3/4"	1/2"	180	135	316

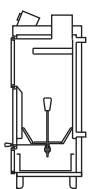

T-22 MYK

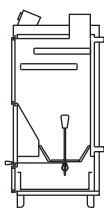

T-28 MYK

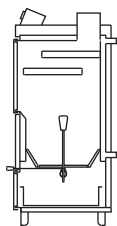

T-35 MYK

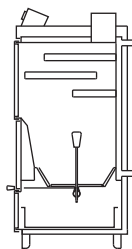

T-45 MYK

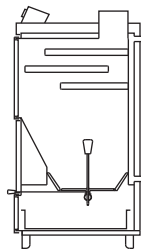

T-60 MYK

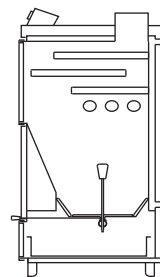

T-80 MYK

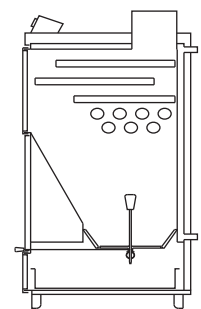

T-100 MYK

DOYK SERIES

T-30/100 DOYK

WITH BAFFLE AUTOMATIC LOADING SOLID FUEL BOILERS

- Manuel /Digital Control Panel
- Large Loading Cover
- Alarm System
- Conventional Ways
- Large Volume ash Pail
- Walnut Coak Firing Opportunity
- Cleaning Front Opportunity
- Silent Operation Feature
- 3-4-5 Pass Flames
- Replaceable Burning Pot
- Wood Firing Opportunity 



Coal



Cone



Wood



Turd



Optional Manuel Control Panel



Optional Digital Control Panel



1,5 Hp Reductor Motor



4-5-6 Pass Flames



Large Volume Fuel Tank



Large Volume Fuel Tank



Sides With Water Burning Pot

TECHNICAL SPECIFICATIONS

Product Code	Capacity (kcal/h)	Dimensions			Radiator Lines	Ventile Lines	Output Fullingline	Flue Diamenter (mm)	Water Volume (Lt)	Weight (Kg)
		Width (mm)	Depth (mm)	Height (mm)						
T-30 DOYK	30 000	580	1600	1300	1"	1"	1"	130	55	247
T-45 DOYK	45 000	580	1650	1400	1¼"	1"	1¼"	150	75	280
T-60 DOYK	60 000	580	1800	1400	1½"	1"	1½"	150	125	375
T-80 DOYK	80 000	630	1900	1500	1½"	1"	1½"	180	150	410
T-100 DOYK	60 000	630	2000	1500	2"	1"	2"	180	185	465

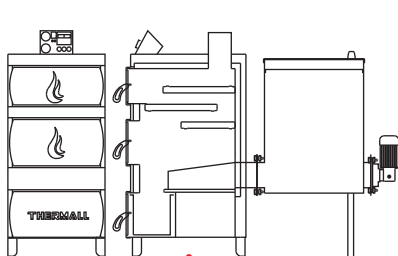

T-30 DOYK

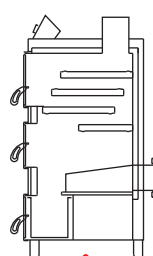

T-45 DOYK

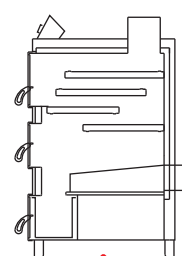

T-60 DOYK

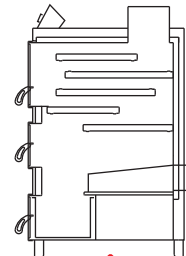

T-80 DOYK

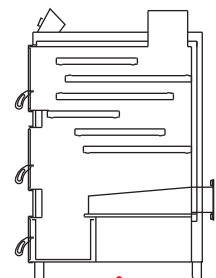

T-100 DOYK

MOYK SERIES

T-250/500 MOYK

CENTRAL SYSTEM AUTOMATIC LOADING HEATING BOILER

- Manuel /Digital Control Panel
- Large Loading Cover
- Alarm System
- Conventional Ways
- Large Volume ash Pail
- Walnut Coak Firing Opportunity
- Cleaning Front Opportunity
- Silent Operation Feature
- 4 Pass Flames
- Replaceable Burning Pot
- Wood Firing Opportunity 



Coal



Cone



Wood



Turd



Optional Manuel Control Panel



Optional Digital Control Panel



1,5 Hp Reductor Motor



Repleceable Burning Pot



Turbulator Flames

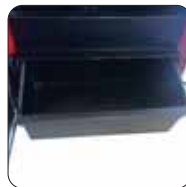

Large Volume Ash Pail



Large Volume Fuel Tank

TECHNICAL SPECIFICATIONS

Product Code	Capacity (kcal/h)	Dimensions			Radiator Lines	Ventile Lines	Output Fullingline	Flue Diamenter (mm)	Water Volume (Lt)	Weight (Kg)
		Width (mm)	Depth (mm)	Height (mm)						
T-22 MYK	22 000	500	470	1160	1"	3/4"	1/2"	130	40	113
T-28 MYK	28 000	500	580	1265	1"	3/4"	1/2"	130	50	144
T-35 MYK	35 000	545	580	1365	1"	3/4"	1/2"	130	65	157
T-45 MYK	45 000	545	650	1465	1 1/4"	3/4"	1/2"	150	80	193
T-60 MYK	60 000	600	790	1465	1 1/2"	3/4"	1/2"	150	100	231
T-80 MYK	80 000	600	790	1565	1 1/2"	3/4"	1/2"	180	125	247
T-100 MYK	100 000	600	850	1665	2"	3/4"	1/2"	180	135	316

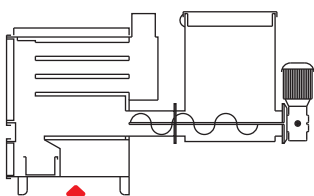

T-250 MOYK

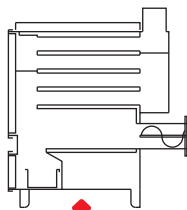

T-300 MOYK

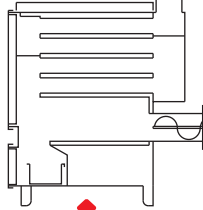

T-350 MOYK

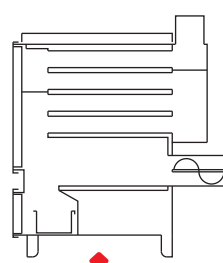

T-400 MOYK

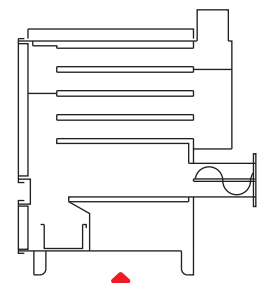

T-500 MOYK

MYIS- OYIS SERIES

T-30/100 MYIS

T-30/100 OYIS

DRY AIR BLOWING STOVES WITH FAN

- Dry Air Blowing System
- Air Diffuser Fan System
- Curtain Cover
- Large Loading Cover
- Elimination and Tilting Lever
- Clock and Fan System
- Flames
- Large Volume ash Pail
- Firebrick Combustion Chamber
- All Solid Kinds Firing Oppotional
- Conversion Around

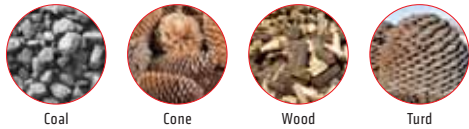

Coal

Cone

Wood

Turd



Air Ways



Elimination Handle



Cleaning Handle



Powerfull Fan



Large Volume Ash Pail



Dish Sahaped Grid



Firebrick Combustion Chamber

TECHNICAL SPECIFICATIONS

Product Code	Capacity (kcal/h)	Manuel Loading Stoves			Automatic Loading Stoves			Flue Diamenter (mm)	Manuel Weight (Kg)	Automatic Weight (Kg)
		Width (mm)	Depth (mm)	Height (mm)	Width (mm)	Depth (mm)	Height (mm)			
T-30 MYIS / OYIS	30 000	570	790	1200	570	1340	1270	130	160	210
T-60 MYIS / OYIS	60 000	620	940	1470	620	1490	1470	150	240	290
T-100 MYIS / OYIS	100 000	670	1140	1560	670	1690	1560	180	480	430

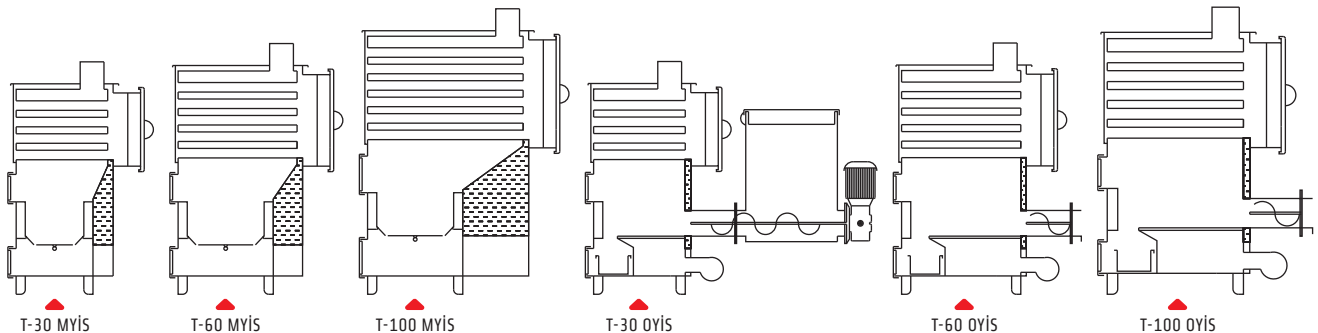

T-30 MYIS

T-60 MYIS

T-100 MYIS

T-30 OYIS

T-60 OYIS

T-100 OYIS

WATER HEATERS

EXCHANGERS

Galvanized Sheet
Serpentine Pipe
Air Security
İzolation
Decorative Appearance
Thermometer
Static Color For Keep
Vertical Using



TECHNICAL SPECIFICATIONS

Product Code	Capacity (kcal/h)	Dimensions		Output Fullingline	In-Out	Weight (Kg)
		Diamenter (mm)	Height (mm)			
Banyo Boyleri	60	380	1050	1/2"	1/2"	32
T-60 BYL	60	380	970	1/2"	1/2"	30
T-80 BYL	80	420	1100	3/4"	3/4"	39
T-100 BYL	100	420	1250	3/4"	3/4"	50
T-150 BYL	150	510	1280	3/4"	3/4"	60
T-200 BYL	200	580	1280	3/4"	3/4"	73
T-300 BYL	300	680	1250	3/4"	3/4"	100
T-500 BYL	500	850	1500	1"	3/4"	125

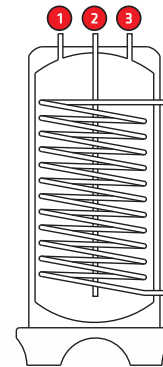

- 1-Ventile Out
- 2-In
- 3-Out
- 4-Radiator In
- 5-Radiator Out

TECHNICAL SPECIFICATIONS

Product Code	Capacity (kcal/h)	Dimensions		Output Fullingline	In-Out	Weight (Kg)
		Diamenter (mm)	Height (mm)			
T-25 ES Eşanjör	25	90	440	1"	1/2"	4,25

INSTANT EXCHANGERS

Vertical and Horizontal Using
360 lt/ h Using Hot Water
12,5 Meter Copper Pipe
Instant Hot Water

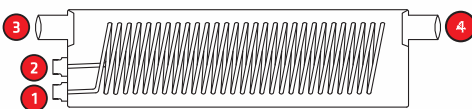

- 1-In
- 2-Out
- 3-Radiator In
- 4-Radiator Out



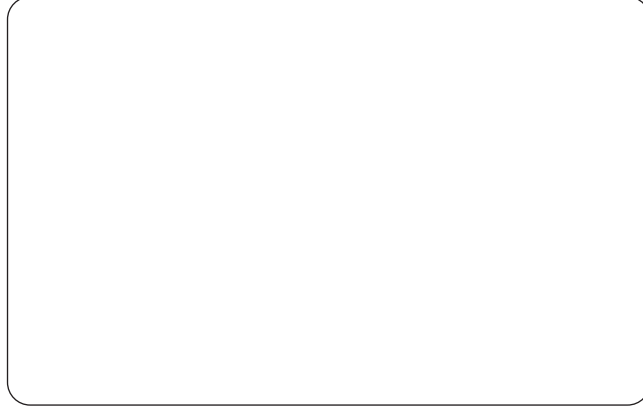

Tatlıcak Mahallesi Konimsan Sanayi Sitesi Umurlu Sokak No:23 Karatay/ Konya- TURKEY
Phone- Fax: +90 332 238 99 68
info@isiksanisistemleri.com info@thermall.com.tr

www.thermall.com.tr

